

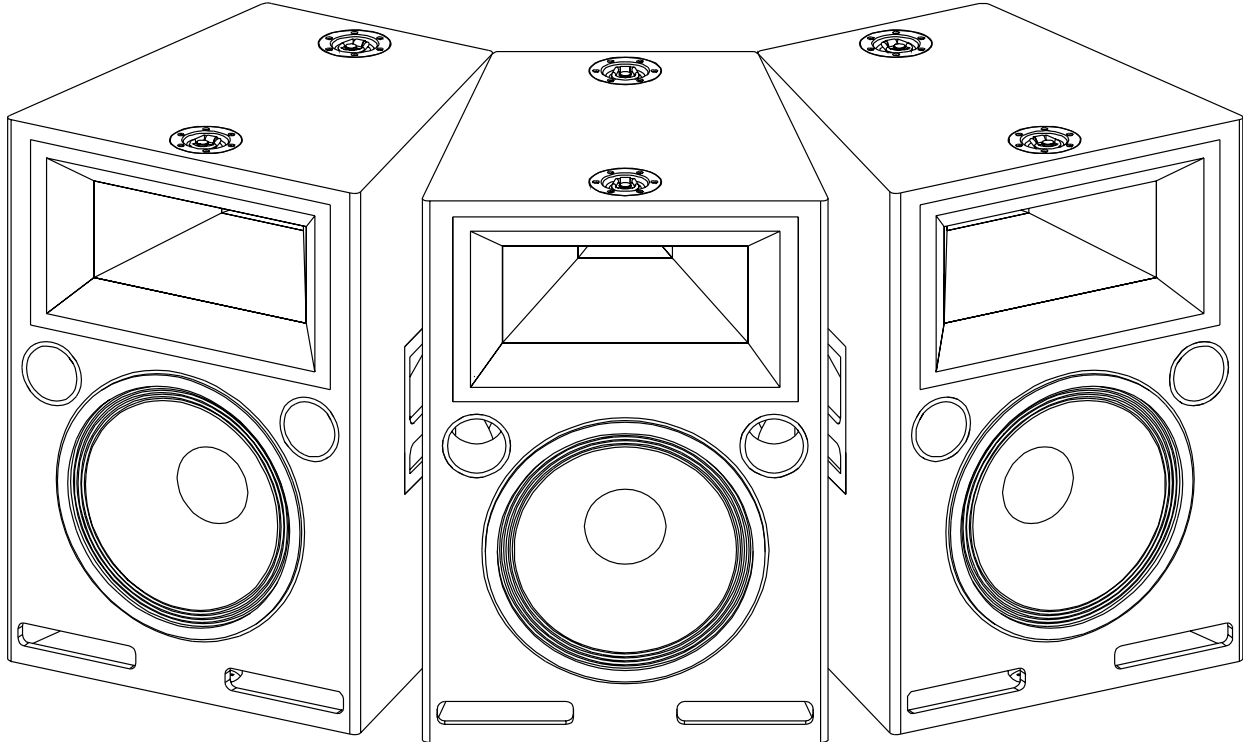

(3) CQ-2's @ 30° Horizontal Splay



Array Coverage and SPL

Coverage:
 Vertical 40°
 Horizontal 110°

Maximum SPL at 1 Meter:
 Peak 142 dB

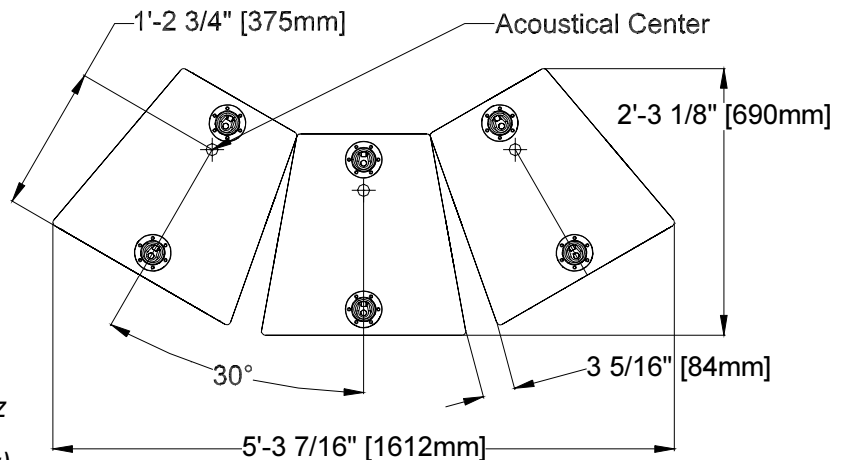

Base Specifications

Frequency Range (Free Field) 40 Hz to 18 kHz

Weight (Before Rigging) 390 lbs. (175.8 kg)

Measurement Notes:

Frequency range constitutes the usable bandwidth after on-axis normalization. Coverage angles measured as the -6 dB (1/4 power) points from the normalized on-axis frequency response averaged over the band from 125 to 8k Hz. All measurements made at 4 meters in an anechoic chamber using the Multi-purpose Acoustic Prediction Program (M.A.P.P.)® at 1/36 octave bands and confirmed at 8 meters outside using pink noise and measured in 1/24 octave bands with SIM® System II.

Date: 11.19.97	Doc #: 01.990.101.68	Rev.A
----------------	----------------------	-------



2832 San Pablo Ave
 Berkeley, CA 94702
 Phone: (510) 486-1166
 Fax: (510) 486-8356
 email: tech@msli.com